

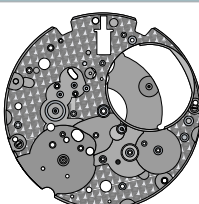

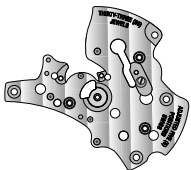





























































## Spare parts list for Calibre 3303

Main plate, jewelled, rhodium-plated	Version	Reference	Chronograph bridge, rhodium-plated	Version	Reference
	3303A	722330310020		3303A	722330315040N
	3303B	7223303B10020		3303B	722330315040
Barrel bridge, jewelled	Version	Reference	Barrel, complete	Version	Reference
	3303A	722330310041		3303A	722330320010
	3303B			3303B	
Wheel train bridge, jewelled	Version	Reference	Barrel drum + barrel cover	Version	Reference
	3303A	722330310048		3303A	722330320040
	3303B			3303B	
Pallet bridge, jewelled, rhodium-plated	Version	Reference	Barrel arbor	Version	Reference
	3303A	722330310057		3303A	722330320060
	3303B			3303B	
Balance bridge, pre-assembled	Version	Reference	Mainspring	Version	Reference
	3303A	722330310058		3303A	722330320100
	3303B	7223303B10058		3303B	
Hammer operating limitation bridge	Version	Reference	Oscillating weight, rhodium-plated	Version	Reference
	3303A	722330310615		3303A	722330322019
	3303B			3303B	
Automatic device framework, jewelled	Version	Reference	Intermediate wheel	Version	Reference
	3303A	722330312030		3303A	722330330012
	3303B			3303B	
Automatic device bridge, pre-assembled	Version	Reference	Great wheel	Version	Reference
	3303A	722330312050		3303A	722330330014
	3303B			3303B	
Date indicator maintaining plate	Version	Reference	Third wheel	Version	Reference
	3303A	722330313105		3303A	722330330025
	3303B			3303B	



























## Spare parts list for Calibre 3303

Second wheel	Version	Reference	Schock-absorber, lower	Version	Reference
	3303A	722330330027**		3303A	722330332062
	3303B			3303B	7223303B70531
Escape wheel	Version	Reference	In settings, upper	Version	Reference
	3303A	722330330040		3303A	7223303A32127
	3303B			3303B	7223313B32127
Ratchet wheel	Version	Reference	In settings, lower	Version	Reference
	3303A	722330331022		3303A	7223303A32167
	3303B			3303B	7223313B32167
Crown wheel	Version	Reference	Cap jewel, lower	Version	Reference
	3303A	722330331023		3303A	7223303A32262
	3303B			3303B	
Minute wheel	Version	Reference	Cap jewel, upper	Version	Reference
	3303A	722330331041S2		3303A	7223303A32325
	3303B			3303B	
Hour wheel	Version	Reference	Schock-absorber spring, top	Version	Reference
	3303A	722330331046**		3303A	7223303A32425
	3303B			3303B	
Cannon pinion with driving wheel	Version	Reference	Schock-absorber spring, bottom	Version	Reference
	3303A	722330331080**		3303A	7223303A32462
	3303B			3303B	
Motion work setting wheel	Version	Reference	Ratchet wheel driving wheel	Version	Reference
	3303A	722330331102		3303A	72233033203301
	3303B			3303B	
Winding pinion	Version	Reference	Wig-wag pinion	Version	Reference
	3303A	722330331120		3303A	722330332104
	3303B			3303B	
Sliding pinion	Kaliber	Reference	Stop pinion	Version	Reference
	3303A	722330331121		3303A	722330332105
	3303B			3303B	
Reduction wheel	Version	Reference	Intermediate date wheel	Version	Reference
	3303A	722330332031S2		3303A	722330333011
	3303B			3303B	
Schock-absorber, upper	Version	Reference	Date indicator driving wheel	Version	Reference
	3303A	722330332025		3303A	722330333020
	3303B	7223313B32027		3303B	

## Spare parts list for Calibre 3303

Date corrector intermediate setting wheel 1	Version	Reference	Yoke	Version	Reference
	3303A	7223303A33082		3303A	722330351050
	3303B			3303B	
Date corrector intermediate setting wheel 2	Version	Reference	Rocking bar	Version	Reference
	3303A	722330333083		3303A	722330351052
	3303B			3303B	
Chronograph wheel	Version	Reference	Setting lever	Version	Reference
	3303A	722330335010**		3303A	722330351083
	3303B			3303B	
Minute-counting wheel	Version	Reference	Setting lever jumper	Version	Reference
	3303A	722330335012**		3303A	722330351090
	3303B			3303B	
Hour-counting wheel	Version	Reference	Click	Version	Reference
	3303A	722330335030**		3303A	722330351120
	3303B			3303B	
Driving wheel for counters	Version	Reference	Stop click	Version	Reference
	3303A	722330335031		3303A	722330352053
	3303B			3303B	
Hour counter additional driving wheel 1	Version	Reference	Date jumper	Version	Reference
	3303A	722330335032		3303A	722330353080
	3303B			3303B	
Hour counter additional driving wheel 2	Version	Reference	Date corrector	Version	Reference
	3303A	722330335033		3303A	722330353200
	3303B			3303B	
Pallet fork	Version	Reference	Column wheel operating lever	Version	Reference
	3303A	722330340010		3303A	722330355040
	3303B			3303B	
Balance complete with stud	Version	Reference	Hammer operating lever	Version	Reference
	3303A	722330340055		3303A	7223303A55048
	3303B	7223303B40055		3303B	
Stud support	Version	Reference	Clutch rocker	Version	Reference
	3303A	722330340210		3303A	722330355090
	3303B			3303B	
Winding stem	Version	Reference	Clutch lever	Version	Reference
	3303A	722330351010		3303A	722330355100
	3303B			3303B	

## Spare parts list for Calibre 3303

Column wheel jumper	Version	Reference	Hour wheel friction spring	Version	Reference
	3303A	722330355130		3303A	722330366220
	3303B				
Minute counter jumper	Version	Reference	Crown wheel core	Version	Reference
	3303A	722330355143		3303A	7223303881136
	3303B				
Chronograph column-wheel	Version	Reference	Dial fastener	Version	Reference
	3303A	722330355180		3303A	722330370200
	3303B				
Chronograph and minute hammer	Version	Reference	Date indicator	Version	Reference
	3303A	722330355240		3303A	722330391440*
	3303B				
Hour hammer	Version	Reference	Screw for stud	Version	Reference
	3303A	722330355248		3303A	72233034002
	3303B				
Eccentric screw	Version	Reference	Screw for automatic device bridge	Version	Reference
	3303A	722330355445		3303A	72233036003
	3303B				
Balance stop lever	Version	Reference	Screw for hammer operating lever	Version	Reference
	3303A	722330356070		3303A	72226016004
	3303B				
Click spring	Version	Reference	Screw for clutch rocker	Version	Reference
	3303A	722330361080		3303A	72226016004
	3303B				
Yoke spring	Version	Reference	Screw for clutch lever	Version	Reference
	3303A	722330361100		3303A	72226016004
	3303B				
Stop click spring	Version	Reference	Screw for Column wheel jumper	Version	Reference
	3303A	722330362101		3303A	72226016004
	3303B				
Date jumper spring	Version	Reference	Screw for Minute counter jumper	Version	Reference
	3303A	722330363030		3303A	72226016004
	3303B				
Column wheel operating lever spring	Version	Reference	Screw for barrel bridge	Version	Reference
	3303A	722330365040		3303A	72233036011
	3303B				
Hammer operating lever spring	Version	Reference	Screw for Hammer operating lever spring	Version	Reference
	3303A	722330365047		3303A	7223612A6012
	3303B				

## Spare parts list for Calibre 3303











Screw for ratchet wheel	Version	Reference	Screw for setting lever jumper	Version	Reference
	3303A	72233036019		3303A	72233037035
	3303B			3303B	
Screw for column wheel operating lever	Version	Reference	Screw for oscillating weight	Version	Reference
	3303A	72233036022		3303A	72233038200
	3303B			3303B	
Screw for Hammer operating limitation bridge	Version	Reference	Screw for pallet bridge	Version	Reference
	3303A	72233036034		3303A	72233038204
	3303B			3303B	
Screw for column wheel operating lever	Version	Reference			
	3303A	72233036204			
	3303B				
Screw for crown boss	Version	Reference			
	3303A	72233036204			
	3303B				
Screw for date indicator maintaining plate	Version	Reference			
	3303A	72233036210			
	3303B				
Screw for Setting lever jumper	Version	Reference			
	3303A	72233036407			
	3303B				
Screw for click	Version	Reference			
	3303A	72233037008			
	3303B				
Screw for chronograph bridge	Version	Reference			
	3303A	72233037031			
	3303B				
Screw for balance-bridge	Version	Reference			
	3303A	72233037031			
	3303B				
Screw for train wheel bridge	Version	Reference			
	3303A	72233037031			
	3303B				
Screw for barrel bridge	Version	Reference			
	3303A	72233037031			
	3303B				
Screw for chronograph bridge (smaller)	Version	Reference			
	3303A	72233037033			
	3303B				
Screw for automatic device bridge	Version	Reference			
	3303A	72233037033			
	3303B				

Fig. 1.0a

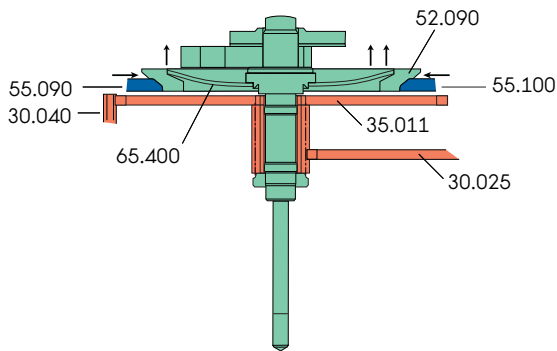
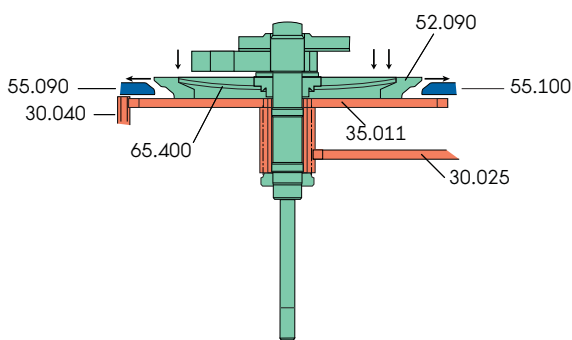

Fig. 1.0b



## 1.0 Chronograph wheel function

### Chronograph wheel 35.010\*

Chronograph wheel 35.010\* is equipped with a coupling system by which the chronograph can be coupled with and uncoupled from the movement's gear-train.

### Do not clean

Chronograph wheel (35.010\*):

The chronograph wheel can only be lubricated during the manufacturing process. Cleaning damages the lubrication and could leave cleaning solution residue at the chronograph wheel, which interferes with operating and timing.

### Chronograph stoppage position

In chronograph stoppage position, clutch disc 52.090 is raised following clamping by clutch rocker 55.090 and clutch lever 55.100, thus avoiding contact with chronograph pinion 35.011 which is constantly coupled with the movement's gear-train.

### Chronograph operating position

In chronograph operating position, clutch disc 52.090 is released simultaneously by clutch rocker 55.090 and clutch lever 55.100. Pushed by chronograph wheel friction spring 65.400, it comes to rest on chronograph pinion 35.011 which will drive it in its travel.

Fig. 1.1

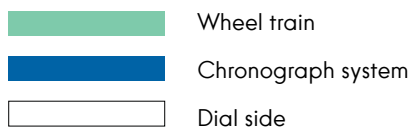

## 1.1 Description of chronograph system

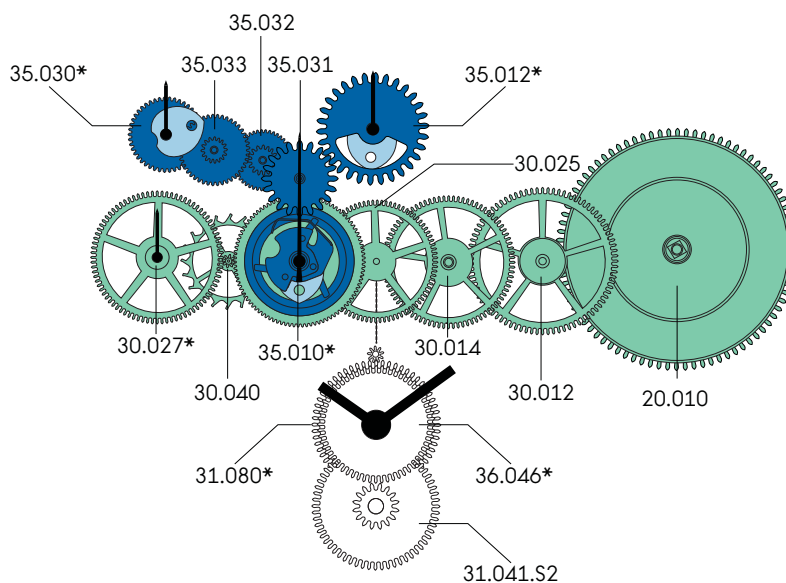
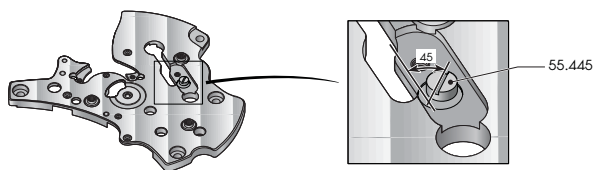

Fig. 2.1



## 2.0 Chronograph setting

### 2.1 Check on the eccentric screw for the counter jumper(55.445)

The eccentric screw (55.445) of the counter jumper (55.143) must be positioned as in the drawing. The slot of the eccentric screw (55.445) must form an angle of 45° in relation to the recess in the bridge. An additional correction is subsequently possible when the chronograph is being set. Do not forget to place the hour hammer (55.248) under the bridge and lubricate it.

Fig. 2.2

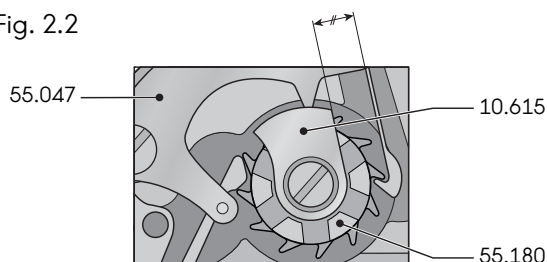

### 2.2 Hammer-lever banking bridge (10.615)

The hammer-lever banking bridge (10.615) prevents the hammer operating lever (55.047) from moving into an unsuitable position. It should be positioned above the hammer operating lever (55.047) and its straight flank should be parallel to the hammer operating lever spring (65.047).

Abb. 2.3

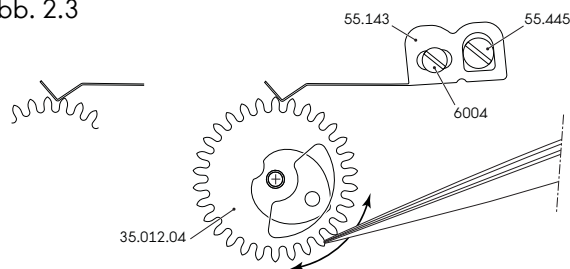

### 2.3 Check on position of minute counter (35.012\*)

Place the chronograph in reset position. Using a plastic or brass point, move the minute counter (35.012\*) slightly to the left and right. It is important that the minute counter should return correctly to its original position. With the eccentric screw (55.445), the position of the counter jumper (55.143) can be corrected.

Fig. 2.4 - Drawing 1

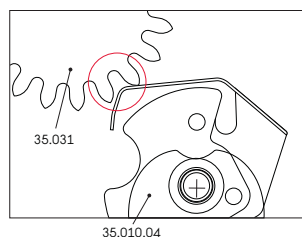
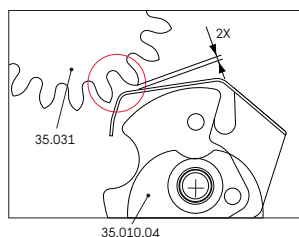

Fig. 2.4 - Drawing 2



### 2.4 Check on location of chronograph finger in reset position

Check the location of the chronograph finger in reset position. To ensure good synchronisation between the second counter and the minute counter, the chronograph finger should be between the position of «slight contact against the tooth» (see drawing 1) and a maximum distance of twice the thickness of the finger blade (see drawing 2).

Fig. 2.5

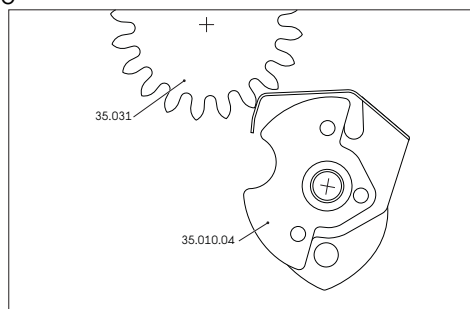

### 2.5 Chronograph finger operating safety

Put the chronograph in START position. Check that the minute counter jump is operating correctly by checking the penetration of the chronograph finger.

### 2.6 Checking the minute jump

In the START position, drive the chronograph hand with a brass or plastic point until the minute jumps. The difference in relation to the position of the chronograph's seconds hand in the zero setting position has a tolerance of 2/5 second. Check the function of the counter jumper (55.143) on the hand.

### 3.0 Runners for hand setting and hand setting force







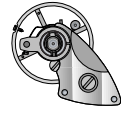

Description	Movement holder for hand setting	No. of runners for hand setting	Minimum force (N)	Maximum force (N)	Support (jewel)
Hour hand	507 0001	6	10	50	No
Minute hand		2	10	50	No
Chrono second hand in the centre		1	40	60	Yes
Second hand (small)		1	10	40	Yes
Hour counter hand		1	25	50	Yes
Minute counter hand		1	25	50	Yes

### 4.0 Epilame coating

#### 4.1 Partial epilame coating

Description	Reference	
Pallet fork **	40010	

#### 4.2 Components that should not be epilam-trearede after cleaning

Description	Reference	
Balance fitted on balance bridge	40055 + 10058°	
In setting, upper *	32127	
In setting, lower *	32167	
Pallet bridge	10057	
Barrel****	20010	
Slipping mainspring	20100	
Hour-counting wheel	35030*	
Chronograph wheel ***	35010*	

\* Do not treat the shock-absorber settings with epilam; the cap jewels should however be treated.

\*\* Pallet fork: Steep only the two gathering pallets in epilame.

\*\*\* Do not clean the chronograph wheel.

\*\*\*\* Do not treat the complete barrel with epilam, only the drum, cover and arbour separately.

For additional information see Working Instructions No 27.



## 5.0 Instantaneous rate

### 5.1 Check of the instantaneous rate

Demagnetise the movement before the checks according to Working Instruction 34.

The rate can be checked with a Witschi Watch Expert or a similar apparatus capable of acoustic measurements. The lift angle has to be set to 51 degrees.

The timing of the movement has to be according to the Omega timing specification list.

Please consult Working Instructions 5 and 28 for instructions and tolerances.

Fig. 5.2

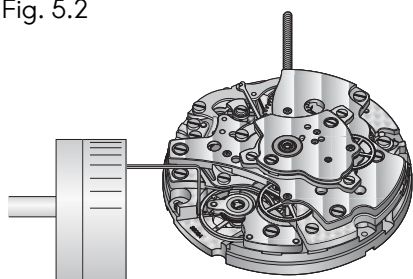
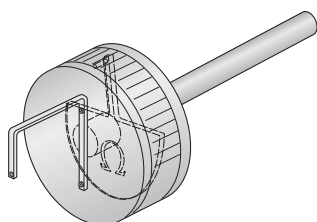
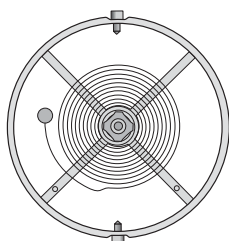

Fig. 5.3



REF. 502 200 0501

Fig. 5.4



### 5.2 Rate adjustment

A special timing key tool has been developed to adjust the rate even when the movement is cased in (see Fig. 5.3). The rate can be corrected according to the table below by turning the two balance screws a complete turn. A scale is found on the outside of the tool. A division corresponds to a rate correction of 1 second. (according to the table below). One screw is located between two arms on the balance which are specially marked by points (see Fig. 5.4) for easy identification of each screw during the correction process.

#### Balance

The annular balance has two adjusting micro-screws. A slow rate deviation is corrected by tightening the micro-screws (towards the centre of the balance), which reduces its moment of inertia and makes it run faster. A fast rate deviation is corrected by loosening the micro-screws (away from the centre of the balance). This increases its moment of inertia and makes it run slower.

#### Important:

The rate is always corrected using **both adjustment screws** to prevent an unbalance of the balance.

Versions A & B identical
One correction revolution = 57 seconds
One graduation = 1 second



## Modifications of Technical Guide versions for Calibre 3303

Technical Guide versions				
First version:	15.02.2006	Version A	Made by:	Pelrom
Second version:	01.04.2006	Version B		
Third version:	05.02.2007	Version C		
Fourth version:	03.04.2007	Version D		
Last version:	11.08.2008	Version E		Rendav

Modifications of Technical Guide version B	
Old version (A)	New version (B)
Tool for checking escapement functions Ref. 506 0002 / Page 4	Tool for checking escapement functions Ref. 506 0004 / Page 4
Titel Exploded view: Movement side Page 6	Titel Exploded view: Dial side Page 6
	Additional drawing of barrel reversed / Page 7
	Additional lubricant point on column wheel on exploded view / Page 8
Screw for column wheel Ref. 72233036033 / Page 15	Screw for column wheel Ref. 72233036034 / Page 15

Modifications of Technical Guide version C	
Old version (B)	New version (C)
Page 4: Tool for checking escapement function	
Page 9: 1 = 61080 2 = 51120 3 = 7008 (1x) 4 = 31022 (1x) 5 = 6019 (1x) 6 = 31023	Page 9: 1 = 12030 2 = 7033 3 = 3203301 4 = 32031S2 5 = 32105 6 = 32104

Modifications of Technical Guide version D	
Old version (C)	New version (D)
Page 3: New version screw since week 07/2002.	Page 3: New version screw since week 35/2004.

Modifications of Technical Guide version E	
Old version (D)	New version (E)
	Update of exploded views Update of the lubrication points Diverse Information

